

REMININGTON®

Keratin Protect Intelligent Straightener



S8598

 www.remington.co.uk

Register online for an EXTRA year guarantee

Visit uk.remington-europe.com/product-registration You must register within 28 days of purchase.

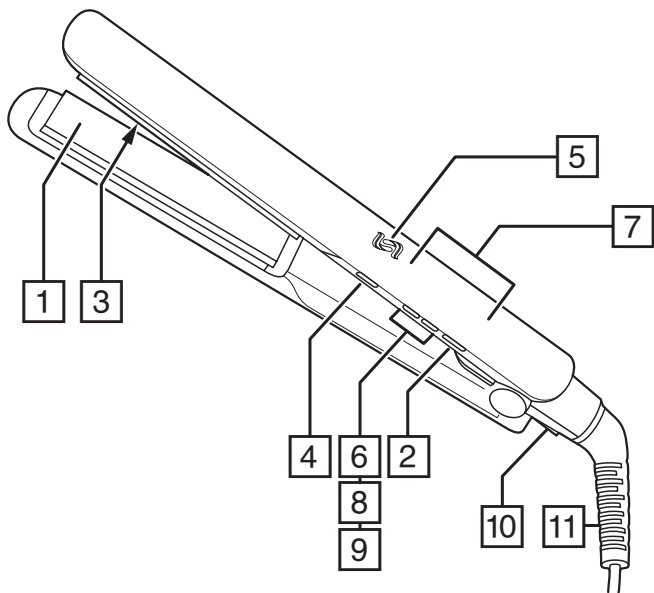

Thank you for buying your new Remington® product. Please read these instructions carefully and keep them safe. Remove all packaging before use.

WARNING: This appliance is hot. Keep out of reach of children at all times.

IMPORTANT SAFEGUARDS

- This appliance can be used by children aged from 8 years and above and persons with reduced physical, sensory or mental capabilities or lack of experience and knowledge if they have been supervised/instructed and understand the hazards involved. Children shall not play with the appliance. Cleaning and user maintenance shall not be done by children unless they are older than 8 and supervised. Keep the appliance and cable out of reach of children under 8 years.
 -  Do not use this appliance near bathtubs, showers, basins or other vessels containing water.
 - When the appliance is used in a bathroom, unplug it after use since the proximity of water presents a hazard even when the appliance is switched off.
 - For additional protection, the installation of a residual current device (RCD) having a rated residual operating current not exceeding 30 mA is advisable in the electrical circuit supplying the bathroom*.
- * Currently, the fitting in a bathroom of an electrical socket suitable or capable of operating the appliance is not permitted in the UK (see BS7671).
- Burn hazard. Keep the appliance out of reach from young children, particularly during use and while cooling down.
 - Never leave the appliance unattended when it is connected to the power supply.
 - Always place the appliance with its stand, if any, on a heat-resistant, stable flat surface.

- If the supply cord of this unit becomes damaged, discontinue use immediately and return the appliance to your nearest authorised Remington® service dealer for repair or replacement in order to avoid a hazard.
- Do not allow any part of the appliance touch the face, neck or scalp.
- Keep the power plug and cord away from heated surfaces.
- Do not use attachments other than those we supply.
- Do not use the appliance if it is damaged or malfunctions.
- Do not twist or kink the cable, or wrap it round the appliance. Check the cord regularly for any sign damage.
- This appliance is not intended for commercial or salon use.
- **WARNING:** Contains traces of nuts.

PARTS

- | | |
|--|--------------------------------------|
| 1. Advanced Keratin and Almond oil ceramic coated 110mm plates | 6. Temperature controls |
| 2. On/Off switch | 7. Temperature display |
| 3. Intelligent heat protection sensor | 8. Temperature boost function |
| 4. Intelligent heat protection sensor On/Off switch | 9. Temperature lock function |
| 5. Intelligent heat protection sensor On indicator icon | 10. Hinge lock |
| | 11. Swivel cord |
| | 12. Heat resistant pouch (not shown) |

ADDITIONAL FEATURES

- Fast heat up—ready to use in 15 seconds.
- Automatic safety shut off – this unit will switch itself off if no button is pressed or it is left on after 60 minutes.
- Multivoltage: for home or abroad. At 120V times and temperatures may vary.

INSTRUCTIONS FOR USE

- Before use, ensure the hair is clean, dry and tangle-free.
- For extra protection use a heat protection spray.
- Hairsprays contain flammable material - do not use while using this product.
- Section the hair prior to styling. Style the lower layers first.
- 1. When your straightener is plugged in but not turned on the lock symbol  will be light up to show that your styler is in standby mode.

- Press and hold the on button to switch on.
- The Heat Protection sensor will automatically be on when the styler is first turned on and this is shown by the  icon. To turn this function off press and hold the Heat Protection Sensor On/Off button.
- Start styling on lower temperatures first. Select the appropriate temperature for your hair type using the "+" and "-" temperature controls on the side of the product.
- The "+" button will increase the temperature and the "-" button will decrease the temperature.

Recommended Temperatures

Temperature	Hair type
160°C - 180°C	Thin / fine, damaged or bleached hair
180°C - 200°C	Normal, healthy hair
200°C - 230°C	Thick and difficult to style hair

- The temperature display will flash until the selected temperature is reached.
- Working on one section at a time run the straightener through the entire length of the hair, without stopping.
- If the Intelligent Heat Protection Sensor is on during styling, the  icon will pulse to tell you that the sensor is monitoring moisture in the hair and is continually optimising the temperature of the plates to prevent damage. These temperature changes are not displayed on the straightener but happen quickly and automatically during styling.

Temperature lock function

- Set the desired temperature using the + and - buttons then lock the settings by pressing the "-" button for 2 seconds. The  symbol will appear on the temperature display.
- To unlock the temperature setting, press and hold the "-" button for 2 seconds.

Temperature boost function

- For quick touch ups of stubborn, hard to style sections.
- The temperature boost function boosts the temperature to 230°C.
- Hold the "+" button for 2 seconds to operate.
- Caution:** the highest temperature is not suitable for every hair type. If you plan to use this straightener on the boost setting of 230°C please test on a small section of your hair first.

STORAGE

Let the appliance cool down before cleaning and storing away

The plates can be locked together for easy storage:

To lock, close the plates and push the hinge lock forwards (towards the plates).

To unlock, slide the hinge lock backwards towards the cord to the unlocked position.

NOTE: Do not heat the unit in the locked position.

CLEANING AND MAINTENANCE

- Unplug the appliance and allow to cool.
 - Wipe all the surfaces with a damp cloth.
 - Don't use harsh or abrasive cleaning agents or solvents.
-

RECYCLING



To avoid environmental and health problems due to hazardous substances, appliances and rechargeable and non-rechargeable batteries marked with one of these symbols must not be disposed of with unsorted municipal waste. Always dispose of electrical and electronic products and, where applicable, rechargeable and non-rechargeable batteries, at an appropriate official recycling/ collection point.

SERVICE AND GUARANTEE



Defects affecting product functionality appearing within the guarantee period will be corrected by replacement or repair at our option provided the product is used and maintained in accordance with the instructions. Your statutory rights are not affected. To claim an extra 1 year guarantee, register your product online within 28 days of purchase.

Register at: <https://uk.remington-europe.com/product-registration>

Consumables are guaranteed only for their recommended lifecycle. Replacement/spare parts* are excluded and are only covered by a 1 year warranty.

*Examples include, but are not limited to, adaptors, haircare attachments, grooming accessories, etc.

SERVICE CENTRE

United Kingdom

 0800 212 438 (free call mainland UK)
Spectrum Brands (UK) Ltd
Fir Street, Failsworth, Manchester
M35 0HS, UK
www.remington.co.uk

Ireland

 142 951 40
Remington Consumer Products,
Unit B12, Ballymount Corporate Park,
Ballymount, Dublin 12
<https://ie.remington-europe.com>

Model No. S8598

19/UK/ S8598 T22-7000649 Version 02 /19

Remington® is a Registered Trade Mark of Spectrum Brands, Inc., or one of its subsidiaries.

Spectrum Brands (UK) Ltd

Fir Street,

Failsworth,

Manchester

M35 0HS

www.remington.co.uk

© 2019 Spectrum Brands, Inc.